



belling

---

**INSIDE  
EVERY  
GREAT  
HOME**

---



User Manual

**Countries of destination:**

GB - Great Britain   
IE - Ireland   
DE - Germany  
ES - Spain

FR - French  
IT - Italy  
PL - Poland  
NL - Netherlands

SE - Sweden  
CN - China  
NZ - New Zealand  
AU - Australia

To contact Belling about your appliance, please call:



**Customer Care Helpline**

**0344 815 3746**

in case of difficulty within the UK



**Warranty Registration**

**0800 952 1068**

\*Please call our Customer Care team for extended warranty



**Spares Store**

**0344 815 3745**



To register your appliance online:

**[www.belling.co.uk](http://www.belling.co.uk)**



To contact us by email:

**[gdhainfo@gdha.com](mailto:gdhainfo@gdha.com)**



To register your appliance by mail:

**Please complete the warranty card and return to the address supplied**



Alternatively general, spares and service information is available from our website at: **[www.belling.co.uk](http://www.belling.co.uk)**

Calls are charged at the basic rate, please check with your telephone service provider for exact charges

Your new appliance comes with our **12-month guarantee**, protecting you against electrical and mechanical breakdown. To register, please complete the registration form included, register online or by phone. For full terms & conditions of the manufacturer's guarantee, please refer to the website above. In addition, you may wish to purchase an extended warranty. A leaflet explaining how to do this is included with your appliance.

Our policy is one of constant development and improvement, therefore we cannot guarantee the strict accuracy of all of our illustrations and specifications. Changes may have been made subsequent to publishing.

# INTRODUCTION

---

This user guide book is designed to help you through each step of owning your new product.

Please read it carefully before you start using your appliance, as we have endeavored to answer as many questions as possible, and provide you with as much support as we can.

General information, spares and service information is available from our website.

If you should find something missing from your product or have any questions that are not covered in this user guide, please contact us (see contact information inside the front cover).

## European Directives

As a producer and a supplier of cooking appliances we are committed to the protection of the environment and are in compliance with the WEEE directive. All our electric products are labelled accordingly with the crossed out wheeled bin symbol. This indicates, for disposal purposes at end of life, that these products must be taken to a recognized collection points,  such as local authority sites/local recycling centres.

This appliance Complies with European Community Directives (CE) for household and similar electrical appliances and Gas appliances where applicable.

This appliance conforms to European Directive regarding Eco design requirements for energy-related products. Our policy is one of constant development and improvement, therefore we cannot guarantee the strict accuracy of all of our illustrations and specifications - changes may have been made subsequent to publishing.

## Disposal of Packaging Material

The packaging materials used with this appliance can be recycled. Please dispose of the packaging materials in the appropriate container at your local waste disposal facilities.

### **UK ONLY GAS WARNING:**

If you smell gas, Do not try to light any appliance. Do not touch any electrical switch.  
Call the Gas Emergency Help line at **0800 111999**

# **SAFETY**

---

## **WARNING**

- If the hob surface is cracked, broken or shattered, switch off the appliance to avoid the possibility of electric shock and call for a service engineer's visit.
- During use the appliance becomes hot. Care should be taken to avoid touching heating elements.
- Children less than 8 years of age shall be kept away unless continuously supervised. This appliance can be used by children aged from 8 years and above and persons with reduced physical sensory or mental capabilities or lack of experience and knowledge if they have been given supervision or instruction concerning the use of the appliance in a safe way and understand the hazards involved. Children shall not play with the appliance. Cleaning and user maintenance shall not be made by children without supervision.
- Do not use harsh abrasive cleaners or sharp metal scrapers to clean the oven door glass or the hob, since they can scratch the surface, which may result in shattering of the glass.
- Do not use a steam cleaner on any cooking range, hob or oven appliance.
- Metallic objects such as knives, forks, spoons and lids should not be placed on the hob surface since they can get hot.
- After use, switch off the hob element by its control and do not rely on the pan detector.
- The appliance is not intended to be operated by means of an external timer or separate control system.
- Unattended cooking on a hob with fat or oil can be dangerous and may result in fire.
- NEVER try to extinguish a fire with water, but switch off the appliance and then cover the flame with a lid or damp cloth.
- Danger of fire: Do not store items on the cooking surfaces.
- Only use hob guards designed by the manufacturer of the cooking appliance or indicated by the manufacturer of the appliance in the instructions for use as suitable or hob guards incorporated in

the appliance. The use of inappropriate hob guards can cause accidents.

- This induction hob complies with the applicable EMC and EMF standards. Therefore it should not interfere with other electronic units. Persons fitted with a pacemaker or any other electrical implant should clarify with their doctor or the producer of the implant, whether there implant is adequate and fail-safe. Please place pans centrally on the cooking zones. The British Heart Foundation provide additional advice regarding using induction hobs when a pacemaker is fitted.
- During use the appliance becomes hot. Care should be taken to avoid touching heating elements.
- Do not modify this appliance.
- Do not place articles on or against the appliance.
- Servicing should be carried out only by authorised personnel.
- Always switch off your appliance and allow it to cool down before you clean any part of it.
- Although every care has been taken to ensure this appliance has no sharp edges. We recommend that you wear protective gloves when installing and moving this appliance. This will prevent injury
- This appliance must be fitted to a switch providing all pole disconnection with a minimum contact separation of 3mm
- Connection should be made with a suitable flexible cable with a minimum temperature rating of 70°C.

## **CAUTION**

- The cooking process has to be supervised. A short term cooking process has to be supervised continuously.
- This appliance must not be installed behind a decorative door in order to avoid overheating.

### **Fire Safety Advice**

If you do have a fire in the kitchen, don't take any risks - get everyone out of your home and call the Fire Brigade.

### **If you have an electrical fire in the kitchen:**

- Pull the plug out, or switch off the power at the fuse box - this may be enough to stop the fire immediately
- Smother the fire with a fire blanket, or use a dry powder or carbon dioxide extinguisher
- Remember: never use water on an electrical or cooking oil fire.

- **Other Safety Advice**
- There is a risk of electric shock, so always make sure you have turned off and unplugged your appliance.
- This appliance must be earthed.
- The appliance must never be disconnected from the mains supply during use, as this will seriously affect the safety and performance, particularly in relation to surface temperatures becoming hot and gas operated parts not working efficiently.
- **GAS WARNING!** - If you smell gas: Do not try to light any appliance, Do not touch any electrical switch. Contact your local gas supplier immediately.

# USING YOUR APPLIANCE

## Getting to know your product

**Note:** Your appliance layout may differ depending on the model.

### Control Panel

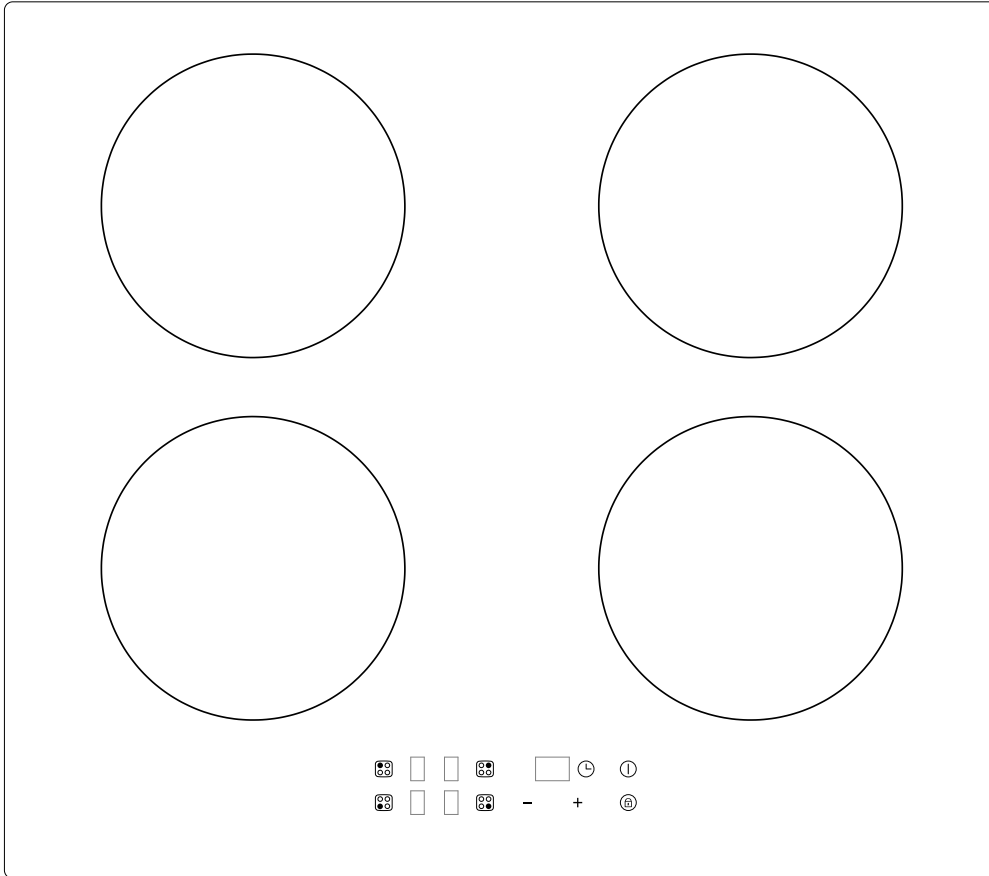

### Hob functions

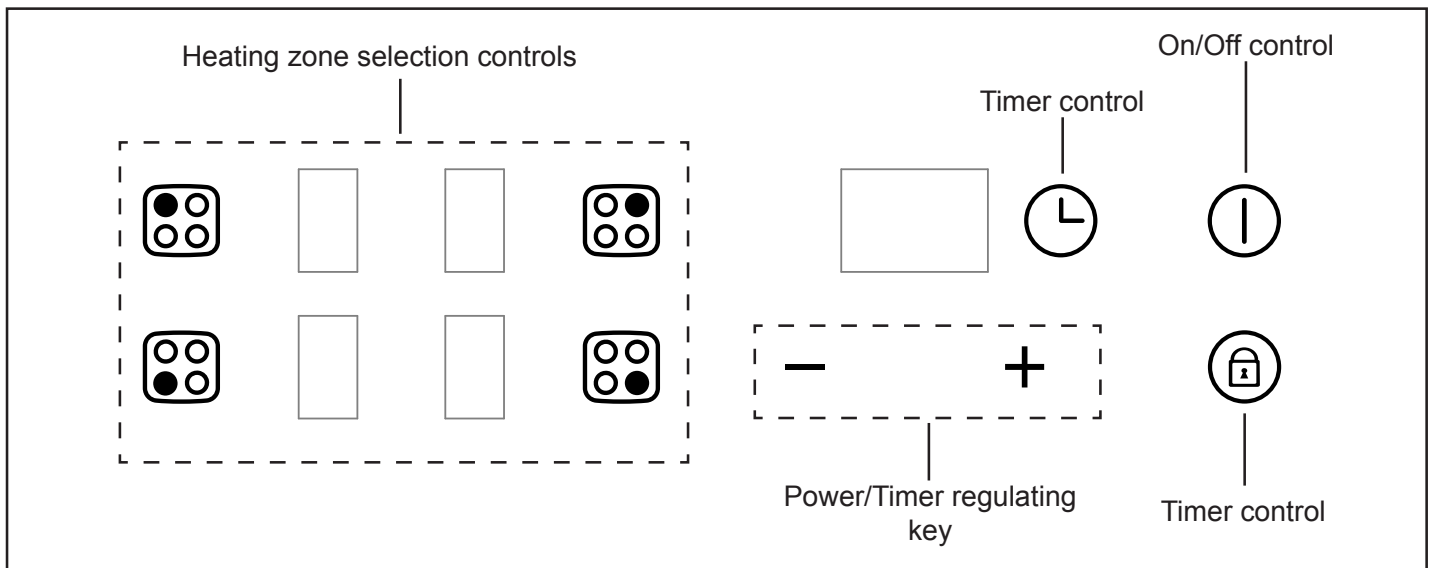

## Before using the Hob

- Read this guide, taking special note of the 'Safety Warnings' section.
- Remove any protective film that may still be on your ceramic hob.

## Touch controls

Use the flat of your finger, not the tip. The controls respond to touch, so you don't need to apply any pressure. The touch control keys take approximately 1 second to respond to your touch. Always ensure the touch control area is clean, dry and free from any objects (e.g. utensils, tea towels and cloths), spillages and water may make the controls difficult to operate. A beeping sound will be activated and will keep on beeping every 10 seconds, to attract your attention, please remove any objects and clean the area as appropriate.

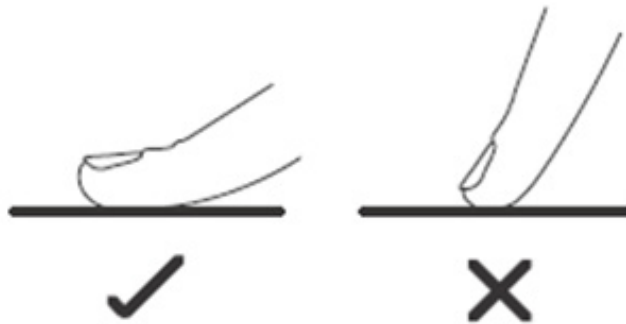

## Choosing the right Cookware

- Only use cookware with a base suitable for induction cooking. Look for the induction symbol on the packaging or on the bottom of the pan.
- You can check whether your cookware is suitable by carrying out a magnet test. Move a magnet towards the base of the pan. If it is attracted, the pan is suitable for induction. The base of the pan must be magnetic across the whole diameter of the base.
- If you do not have a magnet:
  1. Put some water in the pan you want to check.
  2. If  does not flash in the display and the water is heating, the pan is suitable
- Cookware made from the following materials are not suitable: pure stainless steel, aluminium or copper without a magnetic base, glass, wood, porcelain, ceramic, and earthenware.

Do not use cookware with jagged edges or a curved base.





Make sure that the base of your pan is smooth, sits flat against the glass. Use a pan which is at least as large as the circle printed on the glass. Using a pan which is slightly wider than the glass circle printed on the glass will maximise energy-efficiency. Always centre your pan on the cooking zone.

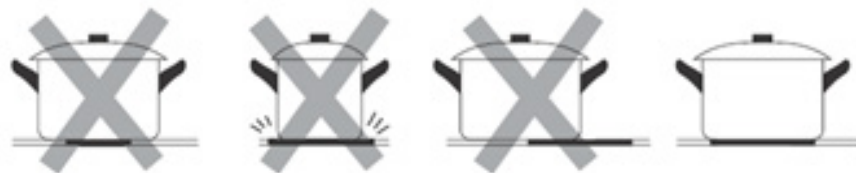

Always lift pans off the ceramic hob – do not slide, or they may scratch the glass.



## Start cooking

After switching the hob on, the buzzer will beep once. All the indicator lights light up for a second and go out, to indicate that the ceramic hob is now in standby mode.

1. Touch the on/off power key until you hear a beep and all the displays show dashes. This indicates that the hob is now in standby mode.



2. Place a suitable pan on the cooking zone that you wish to use.
  - Make sure the bottom of the pan and the bottom of the cooking zone are clean and dry.

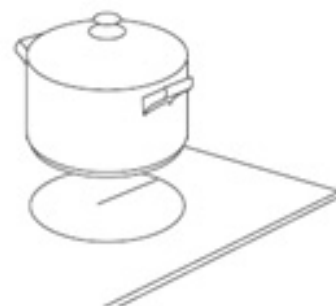

3. Touch the relevant heating zone selection control. An indicator will flash next to the control to indicate which zone is currently selected.

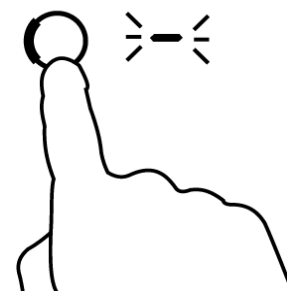

4. While the zone selection indicator is flashing, touch the plus or minus key to select the required power level.

- If a power level is not selected within 1 minute, the induction hob will automatically switch off.
- When needing to modify the power level, touch the relevant heating selection zone key again until the power level indicator is flashing. While the power level indicator is flashing, use the plus or minus key to adjust the power level.

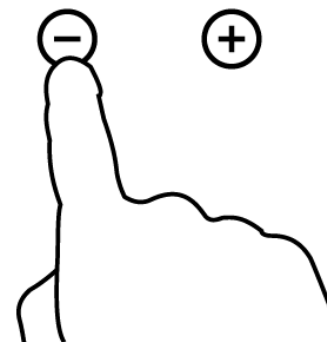

## If the display flashes alternately with the heat setting

This means that:

- You have not placed a pan on the correct cooking zone or;
- The pan you're using is not suitable for induction cooking or;
- The pan is too small or not properly centered on the cooking zone.

No heating takes place unless there is a suitable pan on the cooking zone. The display will automatically turn off after 1 minute if no suitable pan is placed on it.

## Finish cooking

Touch the relevant heating zone selection control for the zone that you wish to turn off. An indicator will flash next to the control to indicate which zone is currently selected.

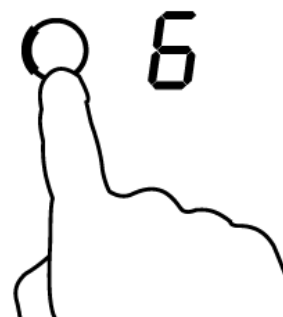

Turn the cooking zone off by touching the minus key repeatedly until the display shows 0, or by touching the plus and minus keys together.

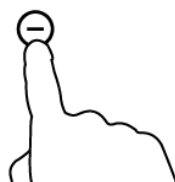

OR

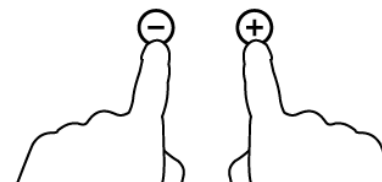

Turn the whole hob off by touching the On/Off control key.



# Locking and unlocking the Controls

- You can lock the controls to prevent unintended use (for example children accidentally turning the cooking zones on).
- When the controls are locked, all the controls except the On/Off control are disabled.

To lock

1. Touch the keylock control key. The timer display will show “LO”.

To unlock

**Note:** Make sure the ceramic hob is turned on.

1. Touch the keylock control key until “LO” disappears from the timer display.

When the keylock function is active, all of the controls are disabled except for the on/off key, so that you can switch the hob off. If you do switch the hob off in this situation, you must first touch and hold the lock key for a few seconds until “LO” disappears from the timer display, before you can switch the hob back on.

## Timer control

You can use the timer in two different ways:

1. You can use it as a minute minder. In this case, the timer will not turn any cooking zone off when the set time has elapsed.
2. You can also set it to turn a cooking zone off after the set time has elapsed. Refer to Setting the timer to turn one cooking zones off.

A maximum duration time of 99 minutes can be set.

## Using the Timer as a Minute Minder

**If you are not selecting any cooking zone**

1. Make sure the hob is turned on.

**Note:** you can use the minute minder even if you're not selecting any cooking zone.

Touch the timer control key. The timer display starts flashing and shows the default value of 10 minutes.

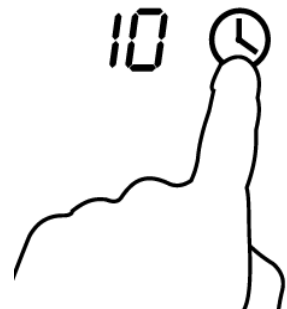

2. While the timer display is flashing, touch the plus or minus keys to set the minute minder duration time.

A short touch of the plus or minus key increases/decreases the time by one minute at a time.

A long press of the plus or minus key increases/decreases time by 10 minutes at a time.

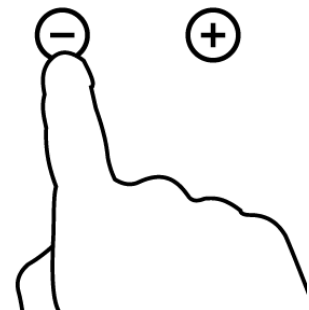

3. While the timer display is flashing, touching the plus and minus keys together returns the time to '00' and cancels the minute minder function.

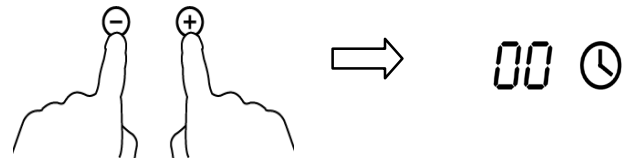

4. A few seconds after the last touch of the plus or minus key, the minute minder duration time is accepted and starts to count down.



5. When the minute minder duration time has elapsed, the buzzer will beep for 30 seconds and the time display shows "--".

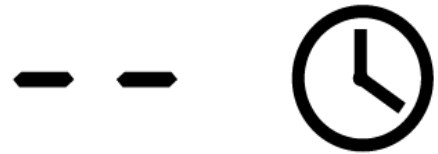

## Setting the timer to turn off one cooking zone at a time

1. First select the relevant heating zone by touching the heating zone selection control, and select the required power level with the plus and/or minus keys.



2. While the heating zone selection indicator is flashing, touch the timer control key. The timer display will start flashing with the default time of 10 minutes showing in the display.



3. While the timer display is flashing, touch the plus or minus keys to set the cooking duration time.

A short touch of the plus or minus key increases/decreases the time by one minute at a time.

A long press of the plus or minus key increases/decreases time by 10 minutes at a time.

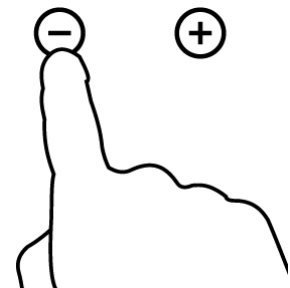

4. About 5 seconds after the last press of the plus or minus key, the timer display stops flashing, and the cooking duration time is accepted and starts to count down on the display.



A red dot will flash next to the relevant power level indicator to show which zone is currently being controlled by the timer.



5. When the cooking duration time has elapsed, the relevant cooking zone will be switched off automatically.

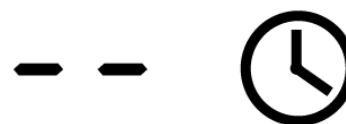

**Note:** If there are other cooking zones in use, which are not being controlled by the timer, then they will continue to operate when the cooking duration time has elapsed, and will not be switched off automatically. The cook-to-off timer can be used to switch one ring off automatically at a time.

## Residual Heat Warning

“H” will show which cooking zone is hot to touch. It will disappear when the surface has cooled down to a safe temperature. It can also be used as an energy saving function if you want to heat further pans, use the hotplate that is still hot.



**Note:** Please be aware that the glass surface may still be warm for a while, even after the ‘H’ indicator has disappeared.

## Default working times

Auto shut down is a safety protection function for your induction hob. It shuts down automatically if ever you forget to turn off a cooking zone. The default working times for various power levels are shown in the below table:

Power level	1	2	3	4	5	6	7	8	9
Default working timer (hour)	8	8	8	4	4	4	2	2	2

## Heat Settings

The settings below are guidelines only. The exact setting will depend on several factors, including your cookware and the amount you are cooking. Experiment with the Ceramic hob to find the settings that best suit you.

Heat setting	Suitability
1 - 2	<ul style="list-style-type: none"><li>• Delicate warming for small amounts of food.</li><li>• Melting chocolate, butter, and foods that burn quickly</li><li>• Gentle simmering</li><li>• Slow warming</li></ul>
3 - 4	<ul style="list-style-type: none"><li>• Reheating</li><li>• Rapid simmering</li><li>• Cooking rice</li></ul>
5 - 6	<ul style="list-style-type: none"><li>• Pancakes</li></ul>
7 - 8	<ul style="list-style-type: none"><li>• Sautéing</li><li>• Cooking pasta</li></ul>
9	<ul style="list-style-type: none"><li>• Stir-frying</li><li>• Searing</li><li>• Bringing soup to the boil</li><li>• Boiling water</li></ul>

# Troubleshooting

Failure code	Problem	Solution
<b>Auto-Recovery</b>		
E1	Supply voltage is above the rated voltage.	There may have been a power surge or issue with the power supply. Please contact your electricity supplier.  Power on after the power supply is normal
E2	Supply voltage is below the rated voltage.	
E3	High temperature of ceramic plate sensor. (1#)	Switch the hob off and allow it to cool down. When the hob has cooled down, press the 'on/off' key to switch it on again. Be careful not to heat up empty pans for too long, and do not allow pans to boil dry.  Touch "ON/OFF" button to restart unit.
E4	High temperature of ceramic plate sensor. (2#)	
E5	The induction unit may be getting too hot. (1#)	Switch the hob off and allow it to cool down. When the hob has cooled down, press the 'on/off' key to switch on again. Start to heat up a pan of water and listen to hear if the cooling fan comes on. If the cooling fan does not come on, or it is noisier than it used to be, please request a service visit.  Touch "ON/OFF" button to restart unit. Check whether the fan runs smoothly; if not , replace the fan.
E6	High temperature of IGBT. (2#)	
<b>No Auto-Recovery Please request a service visit</b>		
F3/F6	Ceramic plate temperature sensor failure- -short circuit. (F3 for 1#, F6 for 2#)	Check the connection or replace the ceramic plate temperature sensor.
F4/F7	Ceramic plate temperature sensor failure--open circuit. (F4 for 1#, F7 for 2#)	
F5/F8	Ceramic plate temperature sensor failure—invalid . (F5 for 1#, F8 for 2#)	
F9/FA	Temperature sensor of the IGBT failure. (short circuit/open circuit for 1#)	Replace the power board.
FC /FD	Temperature sensor of the IGBT failure. (short circuit/open circuit for 2#)	

## Specific Failure & Solution

Failure	Problem	Solution A	Solution B
The LED does not come on when unit is plugged in.	No power supplied.	Check that appliance is switched on at the fused spur cooker point on the wall.	
	Request a service visit from an Engineer to check the connection between the power board and display board.	Check the connection.	
	The accessorial power board is damaged.	Replace the accessorial power board.	
	The display board is damaged.	Replace the display board.	
Some buttons can't work, or the LED display is not normal.	The display board is damaged.	Request a service visit.	
The Cooking Mode Indicator comes on, but heating does not start	High temperature of the hob.	Switch the hob off and let it cool down.  Check the installation to ensure that the air inlets and outlets are not blocked.	
	There is something wrong with the fan.	Check whether the fan runs smoothly; if not, replace the fan.	
	The power board is damaged.	Replace the power board.	
Heating stops suddenly during operation and the display flashes "u".	Pan Type is wrong. Pan diameter is too small.	Use the proper pan (refer to the instruction manual.)	Pan detection circuit is damaged, replace the power board.
	Hob has overheated.	Unit is overheated. Wait for temperature to return to normal.  Push "ON/OFF" button to restart unit.	
Fan motor sounds abnormal.	Request a service visit.	Replace the fan.	



# CLEANING YOUR APPLIANCE

## Do's

**Note:** Always switch off your appliance and allow it to cool down before you clean any part of it.

**Note:** Please take extra care when cleaning over the symbols on the control panel, as this can lead to them fading.

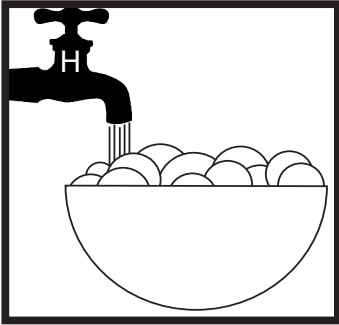

- Warm, soapy water

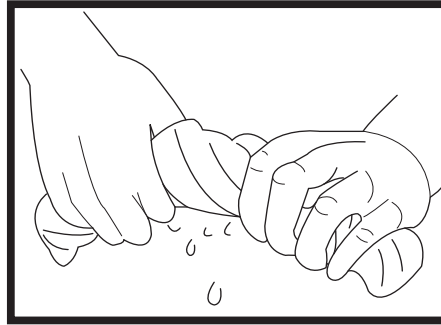

- Clean, wring out cloth

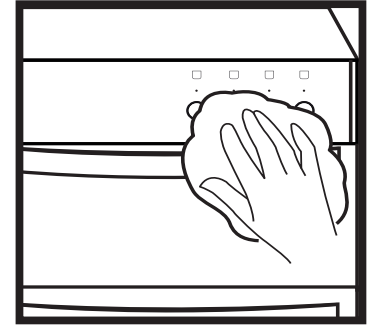

- Wipe with damp cloth
- Dry with a soft cloth

**Tips:** Some foods can mark or damage the metal or paint work e.g.; Vinegar, fruit juices and salt. Always clean food spillages as soon as possible.

## Dont's

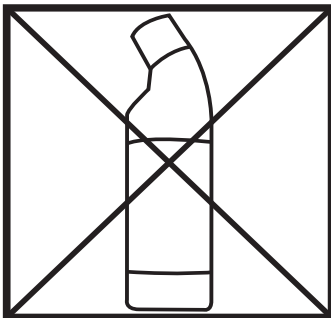

- Undiluted bleaches
- Chloride products

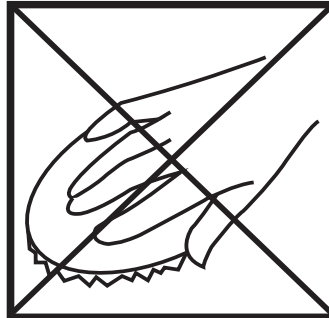

- Wire Wool
- Abrasive cleaners
- Nylon pads
- Steam cleaners

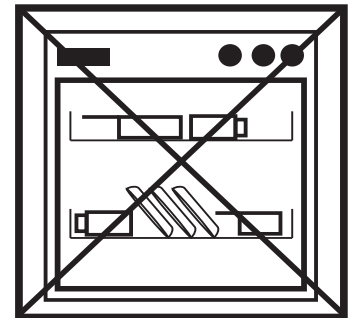

- Do not place in the dishwasher:
- Cast iron griddle
  - Pan supports

**IT IS IMPORTANT TO CLEAN YOUR APPLIANCE REGULARLY AS A BUILD UP OF FAT CAN AFFECT IT'S PERFORMANCE OR DAMAGE IT AND MAY INVALIDATE YOUR GUARANTEE.**

We offer a great range of cleaning products and accessories for your appliance.  
To shop, please visit [www.gdhaonline.co.uk](http://www.gdhaonline.co.uk)

# Installation

## Preparing the worktop cut out

Make a cut-out in the worktop according to the dimensions shown in the table.

For the purpose of installation and use, a minimum of 5cm space shall be preserved around the hole. Be sure the thickness of the work surface is at least 30mm. Please ensure the worktop is made of heat-resistant material to prevent deformations caused by heat from the appliance.

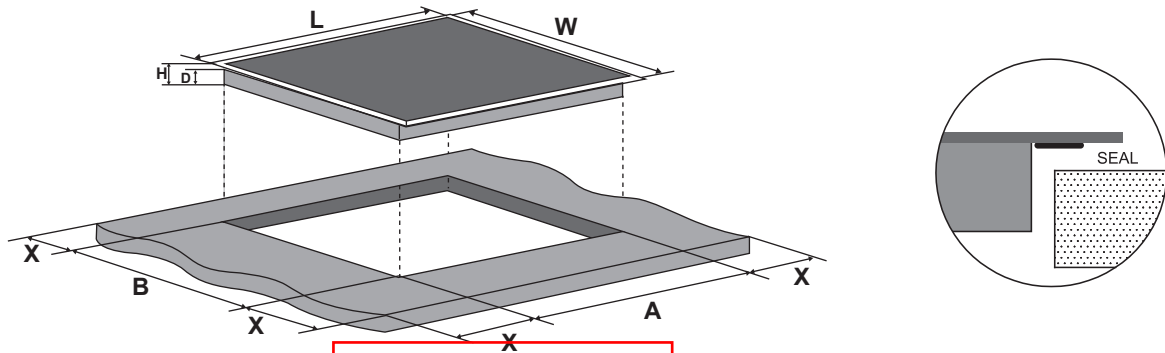

L(mm)	W(mm)	H(mm)	D(mm)	A(mm)	B(mm)	X(mm)
590	520	60	56	560+4 +1	490+4 +1	50 mini

Ensure that the induction hob is well-ventilated and that the air inlet and outlets are not blocked. Make sure that the hob is not damaged in any way. Do not install a damaged hob.

**Note:** The safety distance between the hotplate and the cupboard above the hotplate should be at least 760mm.

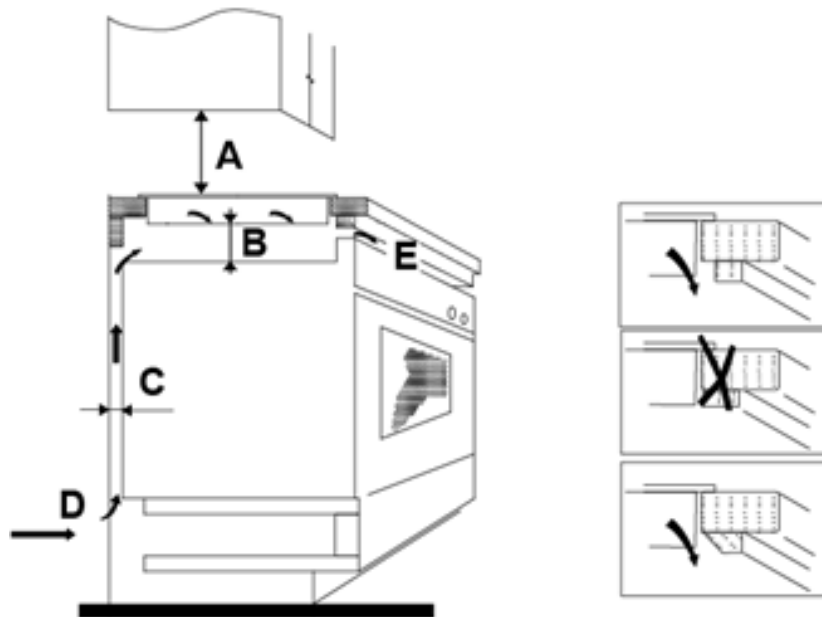

A(mm)	B(mm)	C(mm)	D	E
760	50 mini	20 mini	Air intake	Air exit 5mm

## Before installation

- The work surface is square and level, and no structural members interfere with space requirements.
- The work surface is made of a heat-resistant material.
- If the hob is installed above an oven, the oven has a built-in cooling fan.
- The installation will comply with all clearance requirements and applicable standards and regulations.
- A suitable isolating switch providing full disconnection from the mains power supply is incorporated in the permanent wiring, mounted and positioned to comply with the local wiring rules and regulations.
- The isolating switch must be of an approved type and provide a 3 mm air gap contact separation in all poles (or in all active [phase] conductors if the local wiring rules allow for this variation of the requirements).
- The isolating switch will be easily accessible to the customer with the hob installed.
- You consult local building authorities and by-laws if in doubt regarding installation.
- You use heat-resistant and easy-to-clean finishes (such as ceramic tiles) for the wall surfaces surrounding the hob.

## After installation

- The power supply cable is not accessible through cupboard doors or drawers.
- There is adequate flow of fresh air from outside the cabinetry to the base of the hob.
- If the hob is installed above a drawer or cupboard space, a thermal protection barrier is installed below the base of the hob.
- The isolating switch is easily accessible by the customer.

## Before locating the fixing brackets

The unit should be placed on a stable, smooth surface (use the packaging).

## Adjusting the bracket position

Once the hob has been placed into the worktop with the worktop seal, screw the installation brackets to the underside of the hob. The installation brackets can be installed either way up depending on the thickness of the worktop. There should be a small gap between the installation brackets and the underside of the worktop to allow space for heat expansion.

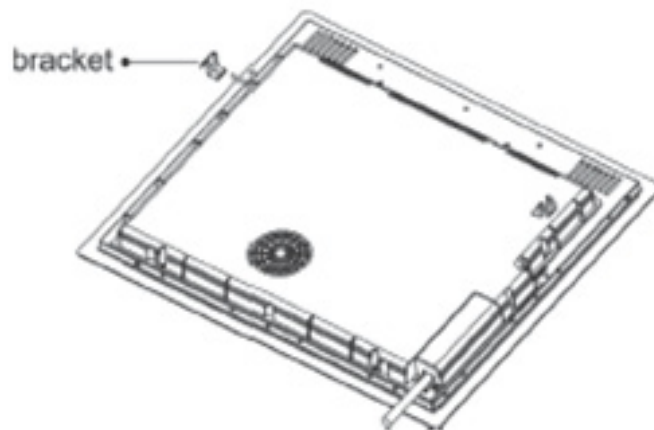

# Connecting the hob to the mains power supply

**Warning:** This appliance must be earthed.

This hob must be connected to the mains power supply only by a suitably qualified person.

Before connecting the hob to the mains power supply, check that:

1. The domestic wiring system is suitable for the power drawn by the hob.
2. The voltage corresponds to the value given in the rating plate.
3. The power supply cable sections can withstand the load specified on the rating plate.

To connect the hob to the mains power supply, do not use adapters, reducers, or branching devices, as they can cause overheating and fire.

The power supply cable must not touch any hot parts and must be positioned so that its temperature will not exceed 75°C at any point.

Check with an electrician whether the domestic wiring system is suitable without alterations. Any Alterations must only be made by a qualified electrician.

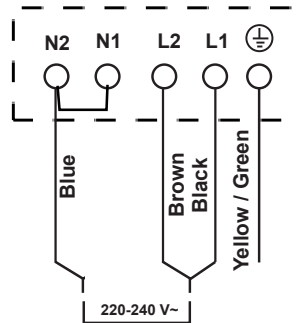

- If the cable is damaged or to be replaced, the operation must be carried out by the service agent with dedicated tools to avoid any accidents.
- If the appliance is being connected directly to the mains electricity supply, an omnipolar circuit-breaker must be installed with a minimum opening of 3mm between contacts.
- The installer must ensure that the correct electrical connection has been made and that it is compliant with safety regulations.
- The cable must not be bent or compressed.
- The cable must be checked regularly and replaced by authorised technicians only.

**This appliance comes with the power cable supplied (1.2m 4 core 2.5mm<sup>2</sup>).**

## Connect to the electricity supply

**Warning:** Ensure that the power rating of the appliance is compatible with a 25Amp supply before connecting to the electricity supply. Check with an electrician whether the domestic wiring system is suitable without alterations.

Should the mains lead of the appliance ever require replacing, we recommend that this is carried out by a qualified electrician who will replace it with a lead of the same size and temperature rating.

# Customer Care

Please keep this handbook in a safe place as the information inside may be of use should you sell, or pass on the appliance. Please fill in the model number and serial number in the spaces provided below as they will assist us should you need to call.

## 0344 815 3746

When you dial this number, you will hear a recorded message and be given several options. This indicates that your call has been accepted and is being held in a queue. Calls are answered in strict rotation as our Customer Care representatives become available.

Enter appliance numbers here for future reference:

<b>Model No</b>									
4	4	4							
<b>Serial No</b>									

These numbers can be found on your appliances data badge. Outside the UK and Northern Ireland, refer to your local supplier.



Stoney Lane, Prescot, Merseyside, L35 2XW.

Please keep this handbook for future reference, or for anyone else  
who may use the appliance.

Please keep this handbook for future reference, or for anyone else  
who may use the appliance.

# TECHNICAL DATA

---

## Hob Details

<b>Cooking hob</b>	<b>IHT602</b>
Cooking Zones	4 Zones
Supply Voltage	220-240V~
Installed Electric Power	7000W
Product Size D x W x H(mm)	590 x 520 x 60
Building-in Dimensions A x B (mm)	560 x 490

Weight and Dimensions are approximate. Because we continually strive to improve our products we may change specifications and designs without prior notice.