

---

# Built in Electric Oven (Side Opening)

LAM3501  
LAM3502



User & Installation Guide

---

**LAMONA**  
Exclusive to Howdens Joinery Co.

Dear Customer,  
Congratulations on your choice of oven which has been designed to give you excellent service.

**The user manual will help you use your product quickly and safely.**

- Please read this user manual before installing and using the oven.
- Always follow the safety instructions.
- Keep this user manual within easy reach for future reference.
- Please read any other documents supplied with the product.

Explanation of symbols

Throughout this user manual the following symbols are used:



Important information or useful tips about usage.



Warning for possible hazards to health and property.



Warning possibility of electric shock.



This product's packaging material is recyclable. Help recycle it and protect the environment by dropping it off in the municipal receptacles provided for this purpose. Your product also contains a great amount of recyclable material. It is marked with this label to indicate the used appliances that should not be mixed with other waste. This way, the appliance recycling organised by your manufacturer will be done under the best possible conditions, in compliance with European Directive 2002/96/EC on Waste Electrical and Electronic Equipment. Contact your town hall or your retailer for the used appliance collection points closest to your home. We thank you doing your part to protect the environment.

# Index

|  |           |  |           |
|--|-----------|--|-----------|
| <b>01 - Before using the oven</b>        | <b>05</b> | <b>08 - Cooking and baking advice</b>              | <b>14</b> |
| Important safety information             | 05        |  |           |
| General                                  | 06        | <b>09 - Cooking tables</b>                         | <b>15</b> |
| Safety for children                      | 07        | Oven cooking table                                 | 15        |
| Safety when working with electricity     | 07        | Grill cooking table                                | 16        |
| <b>03 - General information</b>          | <b>08</b> | <b>10 - Care and maintenance</b>                   | <b>17</b> |
| Oven layout                              | 08        | General information                                | 17        |
| Control panel layout                     | 08        | Cleaning the control panel                         | 17        |
| Accessories                              | 08        | Cleaning the door and removing-<br>the inner glass | 17        |
| <b>04 - Preparation</b>                  | <b>09</b> | Replacing the oven Lamp                            | 18        |
| First cleaning of the appliance          | 09        | <b>11 - Installation</b>                           | <b>19</b> |
| Initial heating                          | 09        | Before installation                                | 19        |
| Tips for energy saving                   | 09        | Installation and connection                        | 20        |
| <b>05 - Operation modes</b>              | <b>10</b> | Connection to the mains supply                     | 20        |
| Operating modes                          | 10        | Cooling Fan  | 21        |
| <b>06 - How to operate the main oven</b> | <b>11</b> | <b>12 - Technical specification</b>                | <b>22</b> |
| Select a temperature and operating mode  | 11        | <b>13 - Troubleshooting</b>                        | <b>23</b> |
| How to use the oven                      | 11        | <b>14 - Your Guarantee</b>                         | <b>24</b> |
| How to use the grill                     | 11        |  |           |
| Shelf positions                          | 11        |  |           |
| Switch off the oven                      | 11        |  |           |
| <b>07 - How to operate the timer</b>     | <b>12</b> |  |           |
| How to operate the oven timer            | 12        |  |           |
| Switch on fully automatic operation      | 12        |  |           |
| Switch on semi-automatic operation       | 12        |  |           |
| Interrupting the cooking process         | 13        |  |           |
| How to activate the program lock         | 13        |  |           |
| Deactivate the program lock              | 13        |  |           |
| How to use the minute minder             | 13        |  |           |
| Switching off the alarm                  | 13        |  |           |



## Important instructions and warnings for safety and environment

- This appliance can be used by children aged from 8 years and above and persons with reduced physical, sensory or mental capabilities or lack of experience and knowledge if they have been given supervision or instruction concerning use of the appliance in a safe way and understand the hazards involved.

Children shall not play with the appliance. Cleaning and user maintenance shall not be made by children without supervision.

- The appliance and its accessible parts become hot during use. Care should be taken to avoid touching heating elements. Children less than 8 years of age shall be kept away unless continuously supervised.

- Do not use steam cleaners to clean the appliance as this may cause an electric shock.

- Only use the connection cable specified in the "Technical specifications".

- If the power connection cable for the product is damaged, it must be replaced by the manufacturer, its service agent or similarly qualified persons in order to avoid a hazard.

- During use the appliance becomes hot. Care should be taken to avoid touching heating elements inside the oven.

- The appliance must be installed so that it can be completely disconnected from the network. The separation must be provided either by a mains plug, or a switch built into the fixed electrical installation, according to construction regulations.

- Accessible parts may become hot during use. Young children should be kept away.

- Do not use harsh abrasive cleaners or sharp metal scrapers to clean the oven door glass since they can scratch the surface, which may result in shattering of the glass.

- Rear surface of the oven gets hot when it is in use. Make sure that the gas/electrical connection does not contact the rear surface; otherwise, connections can get damaged.

- Ensure that the appliance is switched off before replacing the lamp to avoid the possibility of electric shock.

## 01 - Before using the Oven

- Make sure that you have removed all packaging, wrappings, stickers and films from the oven's surface.
- It is recommended that you clean and wash the oven's surface before using for the first time.



This appliance is for domestic cooking purposes only. It must not be used for other purposes, for example room heating, or drying towels and dish cloths. Commercial use will void the guarantee.

The manufacturer shall not be liable for any damage caused by improper use or handling errors.

### General

This product is not intended to be used by persons with physical, sensory or mental disorders or unlearned or inexperienced people (including children) unless they are supervised by a person who will be responsible for their safety or who will instruct them accordingly in the use of the product. Children must be supervised to prevent them from tampering with the product.

- Connect the product to an earthed outlet protected by a fuse of suitable capacity as stated in the "Technical specifications" table. Our company shall not be liable for any problems arising due to the product not being earthed in accordance with the local regulations.
- Do not operate the product if the power cable is damaged. Call qualified service agent.
- Do not carry out any repairs or modifications on the product. However, you may remedy issues that do not require any repairs or modifications. See Troubleshooting, later in this booklet
- Never wash down the product with excessive water, as there is the risk of electric shock!
-  **WARNING FIRE RISK - Do not place aluminium foil, baking trays or cook on the base of this oven, doing so will cause permanent damage to your appliance and cabinetry with the potential risk of fire .**
- Never use the product when your judgment or coordination is impaired by the use of alcohol and/or drugs.
- Product must be disconnected from the mains during installation, maintenance, cleaning and repair procedures.
- Repair procedures must always be performed by qualified service agents. The manufacturer shall not be held responsible for damages arising from procedures carried out by unauthorised persons, which may also void the guarantee.
- Be careful when using alcoholic drinks in your dishes. Alcohol evaporates at high temperatures and may cause fire since it can ignite when it comes into contact with hot surfaces.
- Do not heat closed tins and glass jars in the oven. The pressure that would build-up in the tin/jar may cause it to burst.
- Do not place any flammable materials close to the product as the sides may become hot during use.
- Do not place baking trays, dishes or aluminium foil directly onto the bottom of the oven. The heat accumulation might damage the oven and it's enamel surfaces.
- Do not operate the product if it is defective or has any visible damage.
- Keep all ventilation slots clear of obstructions, as this may cause premature failure of the oven element.
- Parts of the appliance may become hot during or immediately after use. Care should be taken to avoid touching the heating elements, and components inside the oven which maybe hot. Always allow sufficient time for the oven to cool.

- Do not allow the oven to cool with the door open. Even if the oven door is only open a little, front panels of adjacent units could become damaged over time.
- If the door seal is very dirty this can prevent the door from closing properly during use, resulting in possible damage to adjacent furniture and poor efficiency. Always ensure the door seal is clean.
- Product may become hot when it is in use. Please be careful not to touch these hot surfaces.
- Always use heat resistant oven gloves when putting dishes in or removing dishes from the hot oven.
- Do not use the product if any door glass is removed or damaged.
- Rear surface of the oven may get hot when it is in use. Make sure that the electrical connections do not contact the rear surface; otherwise, connections may be damaged.
- Do not trap the mains cable and do not route it over hot surfaces. The cable insulation may melt and cause a fire as a result of a short circuit.
- Make sure that the product function knobs are switched off after every use.
- When hot and cold air meet, condensation can form. The outer door is air cooled and the inner glass will become hot during cooking, therefore some condensation might form. This is perfectly normal. All condensation will disappear as the oven reaches cooking temperature.
- Product must be installed by a qualified person in accordance with the regulations in force. Otherwise, the guarantee may become void.

## Safety for children

Electrical products can be dangerous to children. Keep children away from the product when it is operating and do not allow them to play with or near the product.

“CAUTION: accessible parts of the oven may become hot when the oven or grill is in use. Children should be kept away until the product has cooled down.”

Do not store any items above the appliance that children may reach for.

When the door is open, do not load any heavy object on it and do not allow children to sit on it. The door or door hinges may be damaged.

The packaging materials will be dangerous for children. Keep the packaging materials away from children. Please dispose of all parts of the packaging according to environmental standards.

## Safety when working with electricity

Any work on electrical equipment and systems should only be carried out by authorised and qualified persons.

In case of any damage, switch off the product and disconnect it from the mains. To do this, turn off the fuse at the fuse box.

Make sure that fuse rating is compatible with the product.

 **Do not switch the oven off at the mains isolation switch immediately after cooking. Cooling fan continues to run for up to 20-30 minutes (approx) even after the oven control is turned off.**

## 03 - General Information

### Oven layout

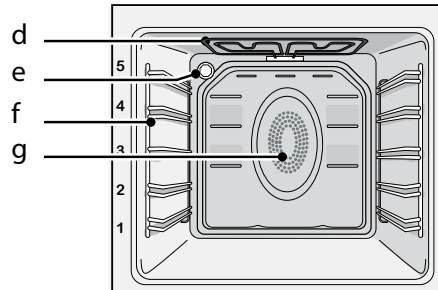
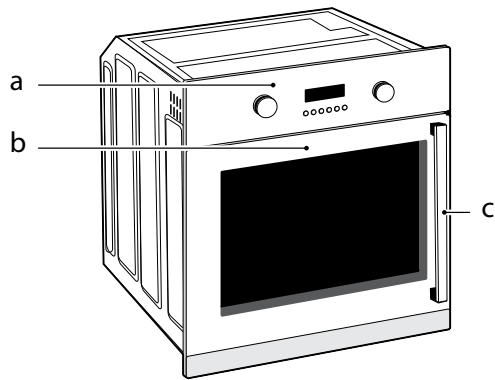

- a. Control panel
- b. Handle
- c. Oven Door

- d. Grill heating element
- e. Light
- f. Oven shelf positions
- g. Heating element and fan

### Control panel layout

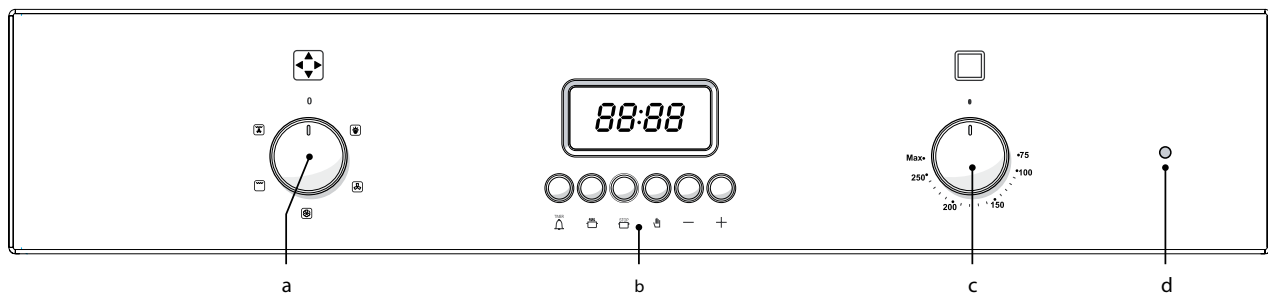

- a. Oven/ grill function knob
- b. Oven programmable timer and clock

- b. Oven temperature indicator
- c. Oven / grill temperature indicator

### Accessories



Oven tray / grill pan

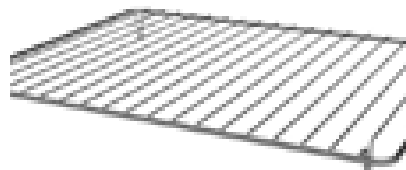

Grill pan wire rack / trivet

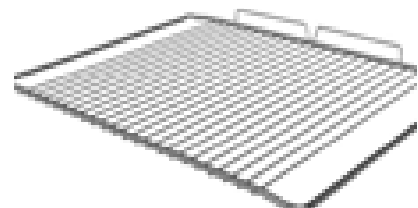

Oven shelf (x2 included)



## 04 - Preparation

### Initial use

**⚠ Before using the oven the clock time must be set. If the clock time is not set, the main oven will not work.**

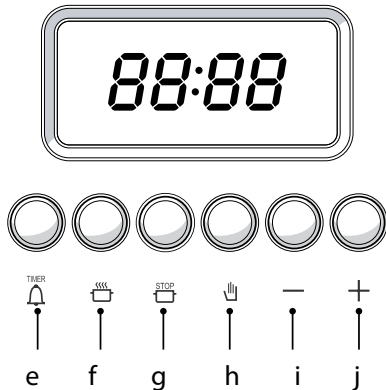

#### Buttons for:

- e. Alarm clock
- f. Cooking time
- g. End of cooking time
- h. Switch on automatic

#### Keys for time adjustment:

- i. Minus button
- j. Plus button

1. To set the time of day, press and hold button 'h'.
2. Whilst continuing to hold button 'h' set the time of day by pressing buttons 'i' or 'j'. The clock will increase or decrease in one minute increments. If you press and hold button 'i' or 'j' for 3 seconds the time will advance quickly
3. Once a time is set release all buttons

### First cleaning of the appliance

1. Remove all packaging materials.
2. Wipe the surfaces of the appliance with a damp cloth or sponge and dry with a clean cloth

The surface may get damaged by some detergents or cleaning materials.

Do not use aggressive detergents, cleaning powder/cream or any sharp objects.

### Initial heating

It is recommended to heat up the product for about 30 minutes and then switch it off. Thus, any production residues or layers will be burnt off and removed.

1. Take the tray and the wire grid out of the oven.
2. Close the oven doors.
3. Select the Fan oven function See How to use the electric oven and grill page 9.
4. Operate oven & grill for about 30 minutes.
5. Turn off your oven & grill and allow to cool.

**⚠** Small amounts of fumes may emit during the initial heating process; this is normal, however monitor the oven at all times and ensure that the room is well ventilated.

### Tips for saving energy

The following information will help you to use your appliance in an ecological way, and to save energy:

- Use dark coloured or enamel coated cookware in the oven as the heat transmission will be better.
- Perform a preheating operation if it is advised in the user manual or cooking instructions.
- Do not open the door of the oven frequently during cooking.
- Try to cook more than one dish in the oven at the same time whenever possible. You can place two cooking vessels onto the wire shelf.
- Cook one dish after another. The oven will already be hot.
- You can save energy by switching off your oven a few minutes before the end of the cooking time. Do not open the oven door.
- Defrost frozen dishes before cooking them if possible.

## 05 - Operating modes

### Operating modes

---

All functions for the oven and grill are listed in this section.

The order of operating modes shown here might deviate from the arrangement on your appliance.

#### Oven Light



This operates the oven internal light only, No heat will be generated, The outside cooling fan may also operating.

#### Defrost



The oven is not heated. Only the fan (in the rear wall) is in operation. Frozen granular food can be thawed slowly at room temperature, and cooked food can be cooled down.

#### Fan Cooking



The element & fan (in the rear wall) are both in operation. Hot air is distributed evenly and quickly all over the cavity by the fan. In most cases, preheating is not required. This mode is suitable when several levels are used for the cooking and an even temperature is required throughout the oven cavity .

#### Grill -Full



The full grill element in the top oven is in operation. This is suitable for grilling larger dishes

Ensure correct shelf position is used, set the temperature to maximum level, and turn the food as required to ensure even cooking.

#### Fan-Grill



The grill effect is not as strong as with normal grilling.

Put small or medium-sized portions in correct shelf position under the grill element for grilling. Set the temperature to maximum level. Turn the food after half of the grilling time.

## 06 - How to operate the oven and grill

### Select temperature & Operating mode

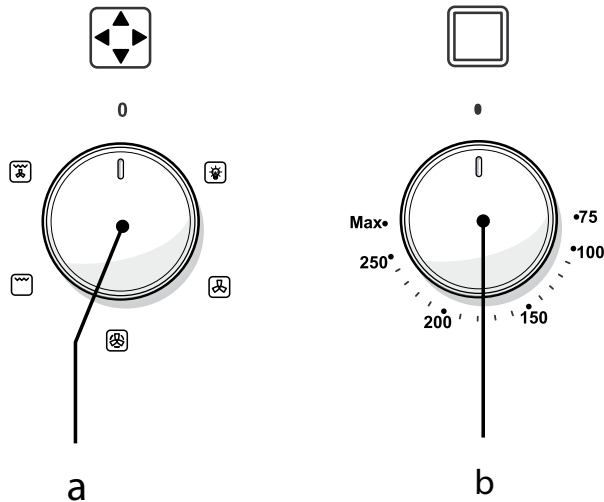

- a. Oven function knob
- b. Oven thermostat knob

The operating modes of the electric oven are selected with the function knob. The temperature is adjusted with the thermostat knob.

### How to use the oven

1. Set thermostat knob to the desired temperature.
2. Set function knob to the required operating mode.
3. Close the oven door

The oven heats up to the adjusted temperature and maintains it. During heating, the temperature indicator light will remain on until the desired temperature is reached.

### How to use the grill

1. Set the function knob to fan grill or full grill symbol.
2. Set grill temperature.
3. Close the oven door
4. Preheat for approximately 5 minutes, if it is necessary.

The grill heats up to the adjusted temperature and maintains it. During heating, the temperature indicator light will remain on until the desired temperature is reached.

**⚠ Hot surfaces may cause burns! Close oven door during grilling.**

### Shelf positions

The oven has 5 shelf positions as illustrated below. It is important to position the wire shelf into the runners correctly.

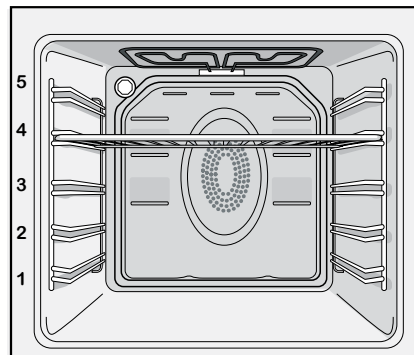

**⚠** Please ensure shelves are fully inserted before closing the oven door, failure to do so could lead to damage to the door.

**Warning** -Do not place aluminium foil or baking trays on the base of the oven. This can lead to permanent damage to your appliance.

**Warning** -Do not place plates, dishes or trays on the floor of oven cavity when oven is in use.

**Warning** - Do not use the oven or grill cavity for storage when not in use.

### Switch off the electric oven/Grill

Turn function knob and thermostat knob to off position (top).

## 07 - How to operate the Timer

### How to operate the oven timer

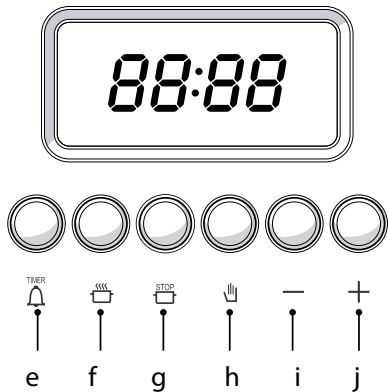

#### Buttons for:

- e. Alarm clock
- f. Cooking time
- g. End of cooking time
- h. Switch on/off automatic mode

#### Buttons for time adjustment:

- i. Minus Button
- j. Plus Button

The maximum time to be set for the end of the cooking process is 23 hours and 59 minutes. In the case of a power cut, the program will be cancelled, and reprogramming is needed.

### Switch on fully automatic operation

In this mode of operation, you can define when the oven is to switch on/off automatically.

#### First, define the end time:

1. Keep button 'STOP' pressed.
2. Set the desired end of cooking time with button '+' or '-'. The clock will increase or decrease in one minute increments. If you press and hold button '+' or '-' for 3 seconds the time will advance quickly.

(The indication "AUTO" will light up on the display.)

3. Once desired end time is reached, release the 'STOP' button.

#### Next define the length of cooking time:

4. Keep button 'STOP' pressed.
5. Set the desired length of the cooking time with button '-' or '+'. The clock will increase or decrease in one minute increments. If you press and hold button '-' or '+' for 3 seconds the time will advance quickly.
6. Once the desired cooking time is programmed release the 'STOP' button.
7. Put your dish into the oven.
8. Select the required operating mode and temperature.

The oven will switch on for the defined length of cooking time prior to specified end time. During the cooking process, the cooking symbol (STOP) on the display is lit.

9. Once the cooking process has been completed and an alarm will sound and heating of the oven will stop.

(The indication "AUTO" on the display goes off.)

10. Switch the oven off by rotating the thermostat and/or the function knob to the off position (top).

### Switch on semi-automatic operation

In this mode of operation, you can define when the oven is to switch off automatically

1. Keep button 'STOP' pressed to define the finish time or 'STOP' to define the length of cooking.
2. Set the desired time with the '+' or '-' buttons. The time will increase or decrease in one minute increments. If you press and hold button '-' or '+' for 3 seconds the time will advance quickly.
3. Once desired time is reached, release the 'STOP' or 'STOP' button.



The indication will "AUTO" light up on the display.

4. Put your dish into the oven.
5. Select operating mode and temperature.



The oven is heated up to the set temperature and keeps this temperature until the end of the cooking time that has been selected. During the cooking process, the cooking symbol on the display () is lit.

6. Once the cooking process has been completed and an alarm will sound and heating of the oven will stop.
7. Switch the oven off with the thermostat knob and/or the function knob.
8. Finally press the '' button to switch off the automatic mode .

The indication "AUTO" on the display goes off.

 If you press button '' during the cooking process, the display will show the remaining cooking time for a short moment.



## Interrupting the cooking process

1. Keep button '' pressed.
2. Keep button '' pressed until "0.00" is shown as remaining cooking time on the display.
3. Release button both buttons.
4. Finally press the '' button to switch off the automatic mode .

» The indication "AUTO" on the display goes off.

5. Switch the oven off by rotating the thermostat and/or the function knob to the off position (top).



## How to Activate the program lock

1. Keep buttons '' and '' pressed simultaneously for 8 seconds until ".On" appears on the display
2. Press button ''.

The display will show ".oF" for 3 seconds and a key symbol will appear.

(The oven timer is now locked.)

## Deactivate the program lock

1. Keep buttons '' and '' pressed simultaneously for 8 seconds until ".oF" appears on the display
2. Press button ''.





The display will now show ".oN" for 3 seconds. (Now the oven timer can be used again.)

## How to use the minute minder

In addition to using the timer for cooking, it can be also used as a minute minder / alarm.

As soon as the defined period of time has expired, the alarm will signal. The minute minder has no influence on the functions of the oven.

### Setting the minute minder

1. Keep button '' pressed.
2. Set the desired time with the '' or '' buttons. The time will increase or decrease in one minute increments. If you press and hold button '' or '' for 3 seconds the time will advance quickly.

The alarm clock symbol on the display lights up.

3. Release '' button.



When you press the '' button while the timer is activated, the display will show the remaining time for a brief moment.

## Switching off the alarm

1. Press button '' to silence the alarm sound.

The timer symbol on the display will disappear

### In order to cancel the minute minder

1. Keep button '' pressed.
2. Simultaneously press the '' until "0.00" is shown as remaining time on the display.
3. Release button all the buttons.

The timer symbol on the display will disappear

## 07 - Cooking and baking advice



Risk of scalding by hot steam! Take care when opening the oven door as steam may escape.

### Tips for baking

- Use nonstick coated appropriate metal trays and containers or heat-resistant silicone moulds.
- Make best use of the space on the shelf.
- It is recommended to place the vessels in the middle of the shelf.
- Select the correct shelf position before turning the oven or grill on - don't move oven shelves when hot.
- Keep the oven door closed.

### Tips for roasting

- Seasoning with lemon juice and black pepper will improve the cooking performance when cooking a whole chicken, turkey or a large piece of meat.
- Meat with bones takes about 15 to 30 minutes longer to cook than a roast of the same size without bones.
- Let meat rest in the oven for about 10 minutes after the cooking time. The juices will be better distributed throughout the meat and will not run out when the meat is cut.
- Fish in a heat proof dish should be placed at the medium or lower level.

### Tips for grilling

- Grilling is ideal for cooking meat, fish and poultry and will achieve nice browning without drying out the food. Flat pieces, meat skewers and sausages are particularly suited for grilling, as are vegetables with a high water content, such as tomatoes and onions.
- Distribute the pieces to be grilled on the wire rack.
- Use tray or grill pan under the wire rack in order to collect dripping fat or juices.
- Adding some water to the grill pan will assist with cleaning.

### Tips for baking cake

- If the cake is too dry, increase the temperature by 10 °C and decrease the cooking time.
- If the cake is wet, use less liquid or lower the temperature by 10 °C.
- If the cake is too dark on top, place it on a lower shelf, lower the temperature and increase the cooking time.
- If cooked well on the inside but sticky on the outside use less liquid, lower the temperature and increase the cooking time.

### Tips for baking pastry

- If the pastry is too dry, increase the temperature by 10 °C and decrease the cooking time. Dampen the layers of pastry with a wash composed of milk, oil, egg.
- If the pastry takes too long to bake, pay attention to the thickness of the pastry you have prepared
- If the upper side of the pastry gets browned, but the lower part is not cooked, make sure that the amount of wash you have used for the pastry is not too much at the bottom of the pastry. Try to spread the wash equally over the pastry for an even browning.
- Cook the pastry in accordance with the mode and temperature given in the cooking table.

### Tips for cooking vegetables

- If the vegetable dish runs out of juice and gets too dry, cook it in a dish with a lid instead of an open tray. Closed vessels will preserve the juice of the dish.
- If a vegetable dish is not cooked, boil the vegetables beforehand.

## 08 - Cooking Tables



The values indicated in the tables below are indicative. They may vary according to the type of food as well as your preferences of cooking.



### Baking and roasting

Level 1 is the bottom level in the oven.



| MAIN OVEN COOKING TABLE   |               |               |                                    |                  |
|---------------------------|---------------|---------------|------------------------------------|------------------|
| Dish                      | Cooking level | Oven Function | Temperature °C                     | Cooking Time min |
| <b>Baking</b>             |               |               |                                    |                  |
| <b>Cakes in tray*</b>     | 1 Level       |               | 175                                | 30 - 40          |
|                           | 2 Levels      |               | 175                                | 45 - 50          |
| <b>Cakes in mould*</b>    | 1 Level       |               | 175                                | 50 - 60          |
|                           | 1 Level       |               | 175                                | 25 - 35          |
|                           | 2 levels      |               | 175                                | 35 - 45          |
| <b>Cakes in bun cases</b> | 3 levels      |               | 180                                | 45 - 55          |
|                           | 1 level       |               | 200                                | 15 - 20          |
| <b>Sponge cake*</b>       | 1 Level       |               | 175                                | 25 - 30          |
|                           | 2 levels      |               | 170 ... 190                        | 35 - 45          |
|                           | 3 levels      |               | 175                                | 30 - 40          |
| <b>Cookies*</b>           | 1 Level       |               | 200                                | 35 - 45          |
|                           | 2 levels      |               | 200                                | 50 - 60          |
|                           | 3 levels      |               | 200                                | 55 - 65          |
| <b>Dough pastry*</b>      | 1 Level       |               | 200                                | 25 - 35          |
|                           | 2 levels      |               | 200                                | 35 - 45          |
|                           | 3 levels      |               | 190                                | 45 - 55          |
| <b>Rich pastry*</b>       | 1 Level       |               | 200                                | 25 - 35          |
|                           | 2 levels      |               | 200                                | 35 - 45          |
|                           | 3 levels      |               | 190                                | 45 - 55          |
| <b>Meat</b>               |               |               |                                    |                  |
| <b>Lasagna*</b>           | 1 level       |               | 200                                | 30 - 40          |
| <b>Roast Beef</b>         | 1 level       |               | 25 min at 250/max then 180 ... 190 | 100 - 120        |
| <b>Leg of Lamb</b>        | 1 level       |               | 25 min at 220 then 180 ... 190     | 70 - 90          |
| <b>Roasted chicken</b>    | 1 level       |               | 25 min at 250/max then 180 ... 190 | 55 - 65          |
| <b>Turkey (5.5kg)</b>     | 1 level       |               | 15 min at 250/max then 190         | 150 - 210        |
| <b>Fish</b>               |               |               |                                    |                  |
| <b>Fish</b>               | 1 level       |               | 200                                | 20 - 30          |

When cooking with 2 trays at the same time, place the deeper tray on the upper rack and the other one on the lower rack.

\* It is suggested to perform preheating for all foods

If cooking requires preheating, heat the oven until the thermostat lamp goes out.

## Grill cooking table

| GRILL COOKING TABLE   |               |   |                    |
|-----------------------|---------------|---|--------------------|
| Food                  | Cooking level | Oven Function   | Cooking Time (min) |
| <b>Fish</b>           | 4 - 5 Level   |  | 20 - 25            |
| <b>Sliced chicken</b> | 4 - 5 Level   |  | 25 - 30            |
| <b>Lamb chops</b>     | 4 - 5 Level   |  | 20 - 25            |
| <b>Steak</b>          | 4 - 5 level   |  | 25 - 30            |
| <b>Toast</b>          | 4 Level       |  | 1 - 2              |

Please Note: cooking times may vary depending on the thickness of food



## 09 - Care and maintenance

### General information

Service life of the product will extend and the possibility of problems will decrease if the product is cleaned at regular intervals.

#### Risk of electric shock!

Switch off the electricity before cleaning appliance to avoid possibility of an electric shock.

#### Hot surfaces may cause burns!

Allow the appliance to cool down before you clean it.

- Clean the product thoroughly after each use. This way it will be possible to remove cooking residues more easily and will avoid burning them on the next time the appliance is used.
- No special cleaning agents are required for cleaning the product. Use warm water with washing liquid, a soft cloth or sponge to clean the product and wipe with a dry cloth.
- Always ensure any excess liquid is thoroughly wiped off after cleaning and any spillage is immediately wiped dry.
- Do not use cleaning agents that contain acid or chloride to clean the stainless steel surfaces and the handle. Use a soft cloth with a liquid detergent (not abrasive) to wipe those parts clean, paying attention to sweep in a horizontal direction.

 The surface may be damaged by some detergents or cleaning materials.

**Do not** use aggressive detergents, cleaning powder/cream or any sharp objects.

**Do not** use steam cleaners for cleaning.

### Cleaning the control panel

Clean the control panel and control knobs with a damp cloth and wipe them dry.

 **Do not** remove the control knobs for control panel cleaning.

### Cleaning oven door and removing the inner glass

#### Hot surfaces may cause burns!

when cleaning make sure that the appliance is switched off and cooled down in order to avoid the risk of an electrical shock or burns.

Don't use any harsh abrasive cleaners or sharp metal scrapers for cleaning the oven door or glass, as they could scratch the surface and damage the oven

The inner door glass can be removed to assist in cleaning.

To remove the glass:

1. open the door fully.
2. The top cap can be pulled away from the retaining clips.

 **Please Note:** When the upper cap is removed, the glass will become loose, therefore care must be taken to support the glass at all times.

3. The glass can now be lifted away from the door assembly.
4. To replace the glass follow this process in reverse ensuring the printed surface of the glass is facing downwards.

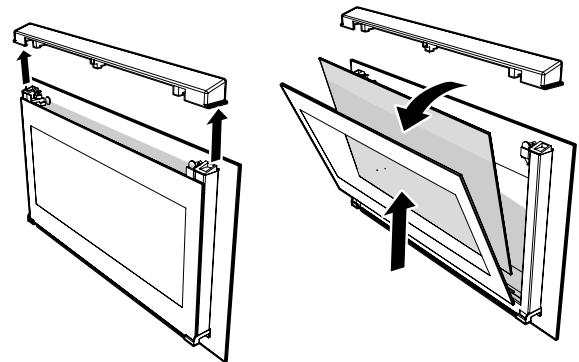

## Replacing the oven lamp

---

**⚠ Hot surfaces may cause burns!**

Make sure that the appliance is switched off and cooled down in order to avoid the risk of an electrical shock or burns.

**i** The oven lamp is a special electric lamp that can resist up to 300 °C. See Technical specifications, for details.

**i** Position of lamp might vary from the diagram.

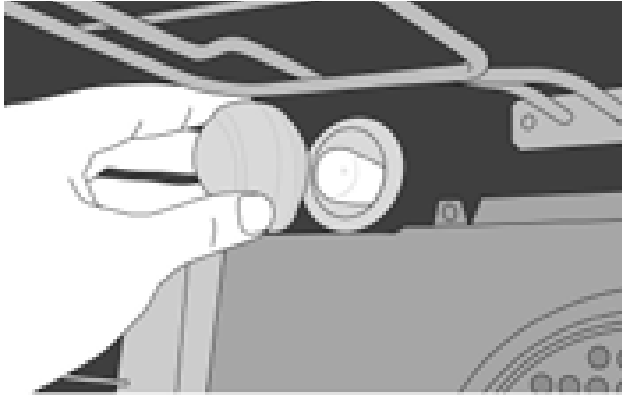



1. Disconnect the product from mains.
2. Turn the glass cover counter clock-wise to remove it.
3. Remove the oven lamp by turning it counter clockwise and replace it with the new one.
4. Install the glass cover

# 10 - Installation

## Before installation

The product should only be installed by suitably qualified persons.

 The product must be installed in accordance with all local regulations.

 Prior to installation, visually check the product for any damage/defects. Do not install if any issues are found.

Damaged products may cause risks to your own safety.

The appliance is intended for installation in Howdens kitchen cabinets.

- Surfaces, synthetic laminates and adhesives used must be heat resistant.
- Kitchen cabinets must be set level and fixed.
- If there is a drawer beneath the oven, a shelf must be installed between oven and drawer.
- The following installation drawings are representational and may not match exactly with your appliance.

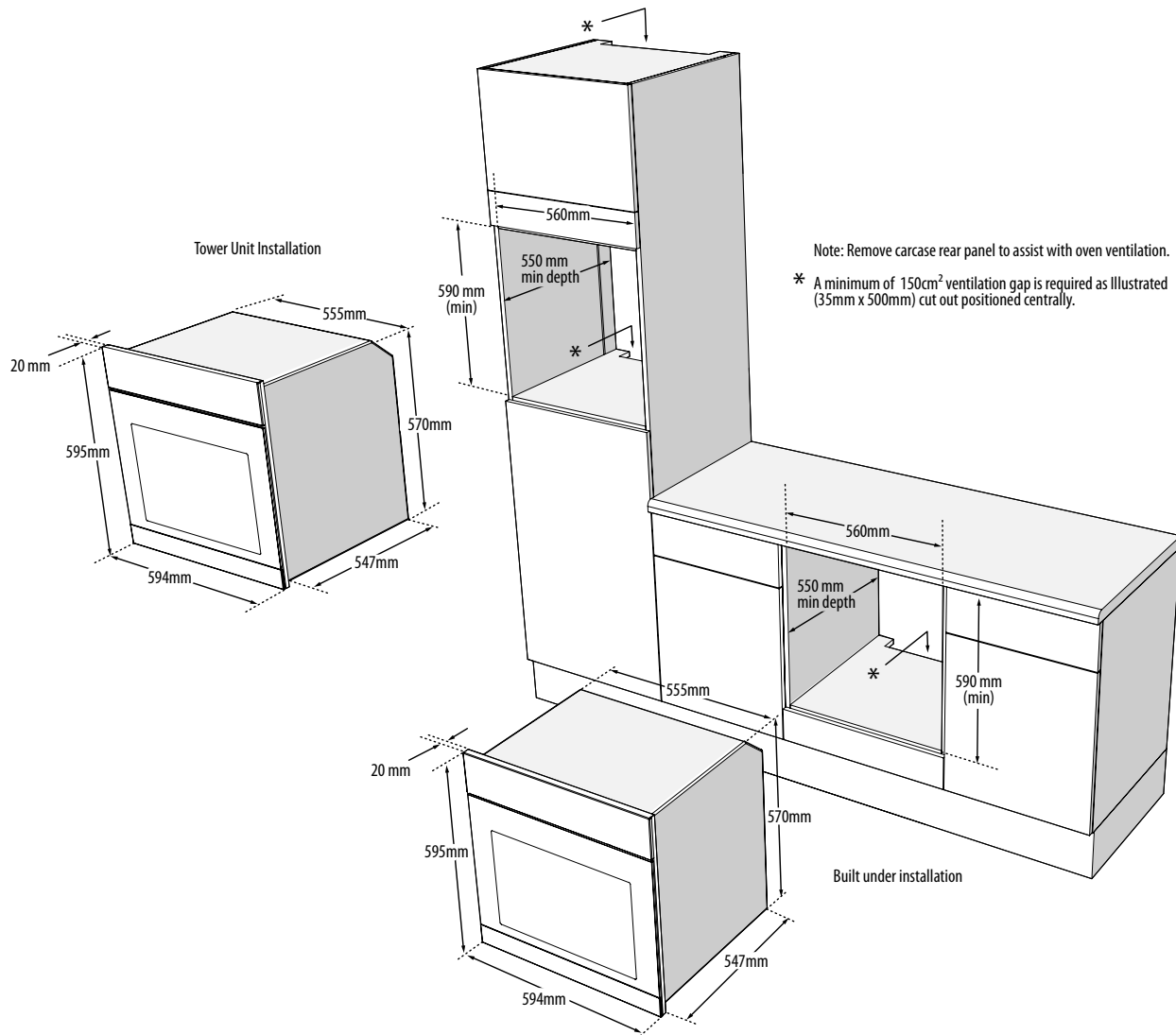

## Installation and connection

### Material damage!

The door and/or handle must not be used for lifting or moving the appliance.

- We recommend 2 people handling of the product.
- Use the handle slots located at both sides of the oven to move the appliance.

## Connection to the mains supply

### This appliance must be earthed!

Howdens shall not be held responsible for any damage caused by using the appliance without an earthed connection.

### Risk of electric shock, short circuit or fire by unprofessional installation!

The appliance may be connected to the mains supply only by an authorized qualified person and the appliance is only guaranteed after correct installation.

### Risk of electric shock, short circuit or fire by damage of the mains lead!

The mains lead must not be clamped, bent, trapped or come into contact with hot parts of the appliance.

If the mains lead is damaged, it must be replaced by a qualified person.

- The mains supply must correspond to the data specified on the rating plate of the appliance. The rating plate can be seen when the main oven door is opened.
- The appliance mains cable must correspond to the specifications and the power consumption; see Technical specifications, page.

 **Risk of electric shock.** Before starting any work on the electrical installation, please disconnect the mains supply.

1. This appliance must only be installed by a qualified electrician, e.g. a local electricity company or a NICEIC registered contractor, to a suitable double-pole control unit with a minimum contact clearance of 3 mm in all poles. The work should be carried out in accordance with IEE regulations. Failure to observe this instruction may result in operational problems and invalidation of the appliance Guarantee.

Additional protection by a residual current circuit breaker is recommended.

2. Open the terminal block cover with screwdriver.
3. Pass the mains lead under the cable clamp and secure clamp with the screw over the outer cable insulation
4. Connect the cables according to the supplied diagram.

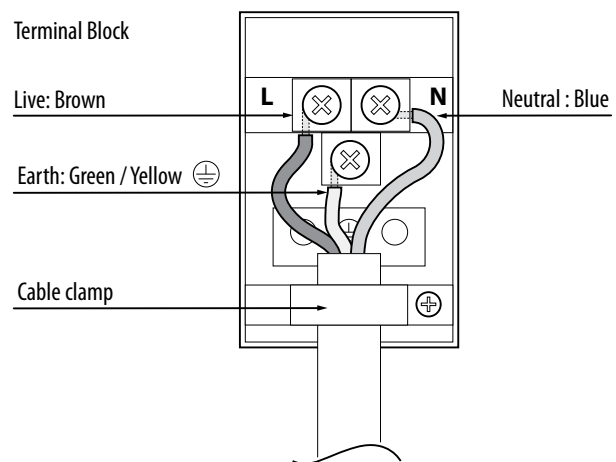

5. Close the cover of the terminal block once the wiring is complete. Mains cable must not be longer than 2 metres for safety reasons.
6. The mains lead should be routed away from the appliance and not be trapped between the appliance and the wall.

**Installation**

Slide the oven through the cabinet aperture, align and secure.

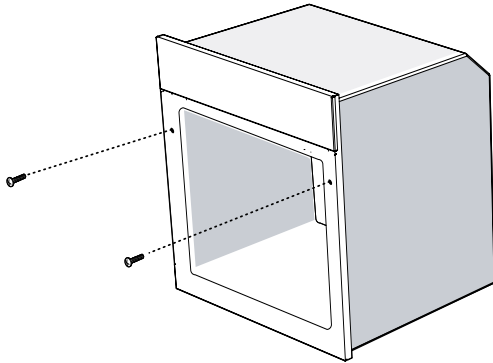

Fix your oven with the 2 screws and washers as indicated in the illustration.

**Final check**

Connect the appliance to the mains supply, switch on the mains supply and check the oven's functions,

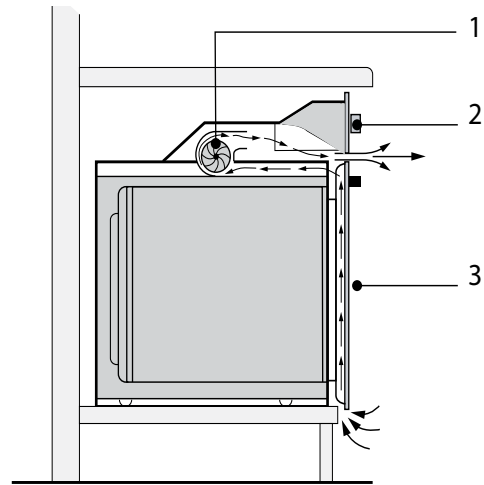
**Cooling fan**

- |   |               |
|---|---------------|
| 1 | Fan           |
| 2 | Control panel |
| 3 | Door          |

The Built-in cooling fan cools both the front of the appliance and cabinetry.

**⚠ Do not switch the oven off at the mains isolation switch immediately after cooking. Cooling fan continues to run for up to 20-30 minutes (approx) even after the oven control is turned off.**

# 11 - Technical specification

## TECHNICAL INFORMATION

### General

|                                |  |
|--------------------------------|--|
| <b>Voltage / Frequency</b>     | 220-240 V ~ 50 Hz                                  |
| <b>Total power consumption</b> | 2.3kW  |
| <b>Fuse</b>                    | min. 13 A  |
| <b>Cable type / section</b>    | H05VV-FG 1.5mm <sup>2</sup> , 3 core or equivalent |
| <b>Cable length</b>            | max. 2m  |

### Oven/Grill

|  |                                    |
|--|------------------------------------|
| External dimensions (height / width / depth)     | 595 mm/595 mm/547 mm               |
| Installation dimensions (height / width / depth) | **590 or 600 mm/560 mm/min. 550 mm |

|                         | Conventional Oven |
|-------------------------|-------------------|
| Energy Efficiency Class | A                 |
| Inner lamp              | 15/25 W           |
| Power consumption       | 2.2 kW            |

# Basics: Information on the energy label of electrical ovens is given in accordance with the EN 50304 standard. Those values are determined under standard load with bottom-top heater or fan assisted heating (if any) functions.

Energy efficiency class is determined in accordance with the following prioritization depending on whether the relevant functions exist on the product or not. 1-Cooking with eco-fan, 2- Turbo slow cooking, 3- Turbo cooking, 4- Fan assisted bottom/top heating, 5-Top and bottom heating.

\*\* See. Installation section.

- Technical specifications may be changed without prior notice to improve the quality of the product.
- Figures in this manual are schematic and may not exactly match your product.
- Values stated on the product labels or in the documentation accompanying it are obtained in laboratory conditions in accordance with relevant standards. Depending on operational and environmental conditions of the product, these values may vary.

## 12 - Troubleshooting

### TROUBLESHOOTING GUIDE

| Symptoms   | Possible Cause  | Solutions   |
|--|---|---|
| <b>Oven emits steam when it is in use.</b>                   | <ul style="list-style-type: none"> <li>Food is being cooked with a high water content</li> </ul>                              | It is normal that steam escapes from food during cooking. This is not a fault.                      |
| <b>Product emits metal noises while heating and cooling.</b> | <ul style="list-style-type: none"> <li>When the oven cavity heats up or cools down parts will expand and contract.</li> </ul> | This is quite normal and the oven is designed to accommodate such movement (this is not a fault).   |
| <b>Product does not operate</b>                              | <ul style="list-style-type: none"> <li>The mains fuse maybe defective or has tripped</li> </ul>                               | Check fuses in the fuse box. If necessary, replace or reset them.                                   |
|  | <ul style="list-style-type: none"> <li>Product is not connected properly.</li> </ul>  | Check all power connections.  |
| <b>Oven light does not work.</b>                             | <ul style="list-style-type: none"> <li>Oven bulb is defective</li> </ul>  | Replace oven bulb   |
|  | <ul style="list-style-type: none"> <li>Power is cut.</li> </ul>   | Check if there is power. Check the fuses in the fuse box. If necessary, replace or reset the fuses. |
| <b>Oven does not heat.</b>                                   | <ul style="list-style-type: none"> <li>Function and/or Temperature are not set.</li> </ul>                                    | Set the function and the temperature with the Function and/or Temperature knob/key.                 |
|  | <ul style="list-style-type: none"> <li>Power is cut.</li> </ul>   | Check if there is power. Check the fuses in the fuse box. If necessary, replace or reset the fuses. |



If you cannot eliminate the problem after following the instructions in this section, consult your depot or the Authorized Service Agent. Never try to repair a nonfunctional product yourself.

## **13 - Your guarantee**

### **Product Guarantee Details (UK only)**

---

**Your appliance has the benefit of a comprehensive manufacturer's guarantee which covers the cost of breakdown repairs. (Details of which are shown on your Proof of Purchase Document).**

- Any claim during the period of the guarantee (MUST BE ACCOMPANIED BY THE PROOF OF PURCHASE)
- The product must be correctly installed and operated in accordance with the manufacturer's instructions and used for normal domestic purposes.
- This guarantee does not cover accidental damage, misuse or alternations which are likely to affect the product.
- The guarantee is invalid if the product is tampered with, or repaired by any unauthorised person.

**(The guarantee in no way affects your statutory or legal rights)**

**What to do if you need to report a problem-**

**Please ensure you have ready:**

- **The product's model & serial numbers**
- **Howdens Proof of Purchase document**
- **Your full contact details**



**Call the Service Line on 0845 00 60 006**







If supplied, please stick your self adhesive product rating plate here, or make a note of the product serial number below in the box below for future reference.

Serial Number : .....



**HOWDENS**

JOINERY CO.

MAKING SPACE MORE VALUABLE



This brochure is printed on FSC certified paper